



McIntosh Laboratory, Inc. 2 Chambers Street Binghamton, New York 13903-2699 Phone: 607-723-3512 www.mcintoshlabs.com

HD Radio® HD Radio™ Technology Manufactured Under License From iBiquity Digital Corp. U.S. and Foreign Patents. HD Radio™ and the HD Radio logo are proprietary trademarks of iBiquity Digital Corp.

MR88
AM/FM/XM/HD Tuner
Owner's Manual

XM Ready XM, SIRIUS and all related marks and logos are trademarks of Sirius XM Radio Inc. and its subsidiaries. All rights reserved.



The lightning flash with arrowhead, within an equilateral triangle, is intended to alert the user to the presence of uninsulated “dangerous voltage” within the product’s enclosure that may be of sufficient magnitude to constitute a risk of electric shock to persons.

WARNING - TO REDUCE RISK OF FIRE OR ELECTRICAL SHOCK, DO NOT EXPOSE THIS EQUIPMENT TO RAIN OR MOISTURE.

IMPORTANT SAFETY INSTRUCTIONS!

PLEASE READ THEM BEFORE OPERATING THIS EQUIPMENT.

1. Read these instructions.
2. Keep these instructions.
3. Heed all warnings.
4. Follow all instructions.
5. Do not use this apparatus near water.
6. Clean only with a dry cloth.
7. Do not block any ventilation openings. Install in accordance with the manufacturer’s instructions.
8. Do not install near any heat sources such as radiators, heat registers, stoves, or other apparatus (including amplifiers) that produce heat.
9. Do not defeat the safety purpose of the polarized or grounding-type plug. A polarized plug has two blades with one wider than the other. A grounding type plug has two blades and a



AVIS RISQUE DE CHOC ELECTRIQUE - NE PAS OUVRIR.

NO USER-SERVICEABLE PARTS INSIDE. REFER SERVICING TO QUALIFIED PERSONNEL.

third grounding prong. The wide blade or the third prong are provided for your safety. If the provided plug does not fit into your outlet, consult an electrician for replacement of the obsolete outlet.

10. Protect the power cord from being walked on or pinched particularly at plugs, convenience receptacles, and the point where they exit from the apparatus.
11. Only use attachments/accessories specified by the manufacturer.
12. Use only with the cart, stand, tripod, bracket, or table specified by the manufacturer, or sold with the apparatus. When a cart is used, use caution when moving the cart/apparatus combination to avoid injury from tip-over.
13. Unplug this apparatus during lightning storms or when unused for long periods of time.
14. Refer all servicing to qualified service personnel. Servicing is required when the apparatus has been damaged in any way, such as power-



The exclamation point within an equilateral triangle is intended to alert the user to the presence of important operating and maintenance (servicing) instructions in the literature accompanying the appliance.

To prevent the risk of electric shock, do not remove cover or back. No user-serviceable parts inside.

supply cord or plug is damaged, liquid has been spilled or objects have fallen into the apparatus, the apparatus has been exposed to rain or moisture, does not operate normally, or has been dropped.

15. Do not expose this equipment to dripping or splashing and ensure that no objects filled with liquids, such as vases, are placed on the equipment.
16. To completely disconnect this equipment from the a.c. mains, disconnect the power supply cord plug from the a.c. receptacle.
17. The mains plug of the power supply cord shall remain readily operable.
18. Do not expose batteries to excessive heat such as sunshine, fire or the like.
19. Connect mains power supply cord only to a mains socket outlet with a protective earthing connection.

Outdoor Antenna Grounding

If an outside antenna or cable system is connected to the product, be sure the antenna or cable system is grounded so as to provide some protection against voltage surges and built-up static charge. Article 810 of the National Electrical Code, ANSI/NFPA 70, provides information with regards to proper grounding of the mast and supporting structure, grounding of the lead-in wire to an antenna discharge unit, and size of ground conductors, location of antenna-discharge unit, connection to ground electrodes and requirements for the grounding electrode.

Example of antenna grounding as per National Electrical Code, ANSI/NFPA 70

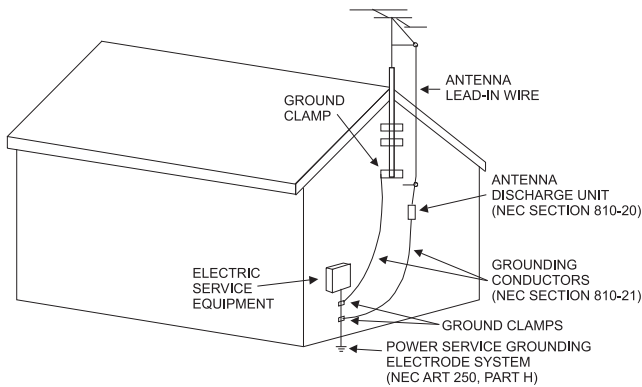

Listening to Satellite Radio

To listen to Satellite Radio, you'll need to connect an XM Satellite Radio tuner (sold separately) to your XM-Ready receiver. XM Satellite Radio is available to residents of the US (except Alaska and Hawaii) and Canada.

Satellite Radio delivers a variety of commercial-free music from categories ranging from Pop, Rock, Country, R&B, Dance, Jazz, Classical and many more plus coverage of all the top professional and college sports including play by play games from select leagues and teams. Additional programming includes expert sports talk, uncensored entertainment, comedy, family programming, local traffic and weather and news from your most trusted sources.

Once you've purchased an XM tuner you'll need to activate and subscribe to begin enjoying the service. Easy to follow installation and setup instructions are provided with the satellite tuners. There are a variety of programming packages available, including the option of adding "The Best of SIRIUS" programming. The "Best of SIRIUS" service is not available to XM Canada subscribers at this time.

Family friendly packages are also available to restrict channels featuring content that may be inappropriate for children.

To subscribe to XM, U.S. customers should visit xmradio.com or call 1-800-XMRADIO (1-800-967-2346); Canadian customers should visit xmradio.ca or call XM Listener Care at 1-877-GETXMSR (1-877-438-9677).

XM Ready Legal

XM, SIRIUS and all related marks and logos are trademarks of Sirius XM Radio Inc. and its subsidiaries. All other marks and logos are the property of their respective owners. All rights reserved. XM subscription sold separately. Taxes and a one-time activation fee may apply. XM tuner and home dock required (each sold separately) to receive the XM service. All programming and fees subject to change. It is prohibited to copy, decompile, disassemble, reverse engineer, hack, manipulate or otherwise make available any technology or software incorporated in receivers compatible with the XM Satellite Radio System. **Service not available in Alaska or Hawaii.**

Table of Contents

Safety Instructions	2
XM Ready Information	3
Table of Contents	3
Thank You and Please Take a Moment.....	4
Technical Assistance and Customer Service	4
General Information	4
Connector and Cable Information	4
Introduction.....	5
Performance Features	5
Dimensions	6
Installation	7

Connections:

Rear Panel and RAA2 Connections	8
How to Connect Antennas and optional XM Components.....	9
How to Connect the MR88	10-11

Remote Control:

Remote Control Push-buttons.....	12
How to use the Remote Control.....	13

Front Panel and Setup:

Front Panel Displays, Controls and Push-buttons....	14
Setup	15-18

Operation:

How to Operate the MR88.....	20-27
------------------------------	-------

Additional Information:

XM Radio Diagnostic Assistance.....	28-29
Specifications.....	30
Packing Instruction.....	31



Thank You

Your decision to own this McIntosh MR88 AM/FM/XM/HD Tuner ranks you at the very top among discriminating music listeners. You now have “The Best.” The McIntosh dedication to “Quality,” is assurance that you will receive many years of musical enjoyment from this unit.

Please take a short time to read the information in this manual. We want you to be as familiar as possible with all the features and functions of your new McIntosh.

Please Take A Moment

The serial number, purchase date and McIntosh Dealer name are important to you for possible insurance claim or future service. The spaces below have been provided for you to record that information:

Serial Number: _____

Purchase Date: _____

Dealer Name: _____

Technical Assistance

If at any time you have questions about your McIntosh product, contact your McIntosh Dealer who is familiar with your McIntosh equipment and any other brands that may be part of your system. If you or your Dealer wish additional help concerning a suspected problem, you can receive technical assistance for all McIntosh products at:

McIntosh Laboratory, Inc.
2 Chambers Street
Binghamton, New York 13903
Phone: 607-723-3512
Fax: 607-724-0549



Customer Service

If it is determined that your McIntosh product is in need of repair, you can return it to your Dealer. You can also return it to the McIntosh Laboratory Service Department. For assistance on factory repair return procedure, contact the McIntosh Service Department at:

McIntosh Laboratory, Inc.
2 Chambers Street
Binghamton, New York 13903
Phone: 607-723-3515
Fax: 607-723-1917

General Information

1. For additional connection information, refer to the owner’s manual(s) for any component(s) connected to the MR88 AM/FM/XM/HD Tuner.
2. The Main AC Power going to the MR88 and any other McIntosh Component(s) should not be applied until all the system components are connected together. Failure to do so could result in malfunctioning of some or all of the system’s normal operations. When the MR88 and other McIntosh Components are in their Standby Power Off Mode, the Microprocessor’s Circuitry inside each component is active and communication is occurring between them.
3. The MR88 is an XM Ready® Tuner. For reception of XM Radio Programs using the MR88, the XM Mini-Tuner with Home Dock and a monthly service subscription are required. The XM Mini-Tuner with Home Dock and monthly service subscription are both sold separately. Contact your McIntosh Dealer for additional information.
4. The Balanced and Unbalanced Outputs may be used simultaneously.

5. The Remote Control Supplied with the MR88 Tuner is capable of operating other components. For additional information go to www.mcintoshlabs.com.
6. When discarding the unit, comply with local rules or regulations. Batteries should never be thrown away or incinerated but disposed of in accordance with the local regulations concerning battery disposal. 
7. For additional information on the MR88 and other McIntosh Products please visit the McIntosh Web Site at www.mcintoshlabs.com. 

Connector and Cable Information

XLR Connectors

Below is the Pin configuration for the XLR Balanced Output Connectors on the MR88. Refer to the diagrams for connections:

- PIN 1: Shield/Ground
- PIN 2: + Signal
- PIN 3: - Signal

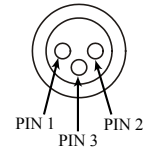

Power Control Connectors

The MR88 Power Control Input/Output Jacks receive/send Power On/Off Signals when connected to other McIntosh Components. A 1/8 inch stereo mini phone plug is used for connection to the Power Control Input/Output on the MR88.

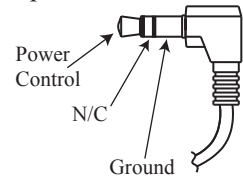

*Note: The Data and Power Control Connecting Cable is available from the McIntosh Parts Department: **Data and Power Control Cable Part No. 170-202** Six foot, shielded 2 conductor, with 1/8 inch stereo mini phone plugs on each end.*

Data and IR Input Port Connectors

The MR88 Data In Port receives Remote Control Signals. A 1/8 inch stereo mini phone plug is used for connection. The IR Port also use a 1/8 inch stereo mini phone plug and allow the connection of other brand IR Receivers to the MR88.

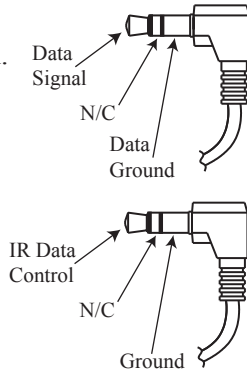

RAA2 Connectors

Pin No.	Wire Color
1.	White/Orange
2.	Orange
3.	White/Green
4.	Blue
5.	White/Blue
6.	Green
7.	White/Brown
8.	Brown

*Cable outer shield

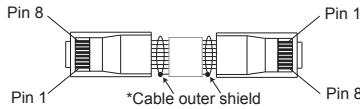

*Note: The RAA2 Connecting Cable is available from the McIntosh Parts Department:
RAA2 Antenna Cable Part No. 171844
 Twenty foot, shielded 8 conductor, with a shielded RJ45 connector on each end.*

Introduction

The MR88 AM/FM/XM/HD Tuner is an elegant instrument for superb reception from both Terrestrial and Satellite Radio Stations. The MR88 uses the latest in technology for the best sound quality, along with the convenient operation of a Dial Glass with Tuning Pointer used in classic McIntosh Analog Tuners.

Performance Features

• HD Reception Radio for both AM and FM Stations

The sound quality of a received HD Radio™ FM Broadcast is of “CD-Quality”. This includes an extended Frequency Response and greater Stereo Channel Separation with non existing reception noise, interference and multi path. HD Radio™ AM Broadcast reception has sound quality equivalent to a good FM-Stereo Broadcast, again with no reception noise or interference.

• Multiple Programs with Information Service

The HD Radio Broadcast format allows a radio station to send out multiple programs simultaneously. The MR88 will indicate various text information such as Station Call Sign, Music Genre, Artist Name and Song Title when transmitted by the Radio Station.

• Optional XM Radio

With the addition of XM Radio, choose from over 170 different Channels, Commercial-Free Music Channels, over 5,000 Live Sports Broadcasts, the Biggest Names in News & Talk and all with Digital Quality Sound.

HD Radio™ Technology Manufactured Under License From iBiquity Digital Corp. U.S. and Foreign Patents. HD Radio™ and the HD Radio logo are proprietary trademarks of iBiquity Digital Corp.

• Special FM RF Tuned Circuitry

The MR88 Tuned RF Circuitry receives strong local FM Station Signals without distortion and receives even the weakest of FM Signals with low noise.

• RAA2 External AM Antenna

The RAA2 External AM Antenna allows placement of the AM Antenna for the best reception.

• Preset Stations and Permanent Memory

The MR88 Tuner stores up to twenty AM, FM and XM Station presets and they are retained in Permanent Memory.

• Multiple Outputs

The MR88 provides unbalanced, balanced, digital coaxial and optical audio outputs.

• Multifunction Fluorescent Display

The Front Panel Display indicates various setup and tuner functions.

• Fiber Optic Solid State Front Panel Illumination

The even Illumination of the Front Panel is accomplished by the combination of custom designed Fiber Optic Light Diffusers and extra long life Light Emitting Diodes (LEDs).

• Glass Front Panel and Super Mirror Chassis Finish

The famous McIntosh Illuminated Glass Front Panel and the Stainless Steel Chassis with Super Mirror Finish ensures the pristine beauty of the MR88 will be retained for many years.



Dimensions

The following dimensions can assist in determining the best location for your MR88.

Front View of the MR88

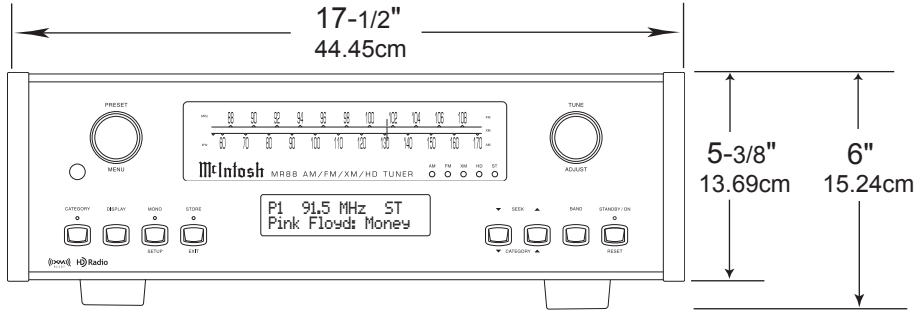

Rear View of the MR88

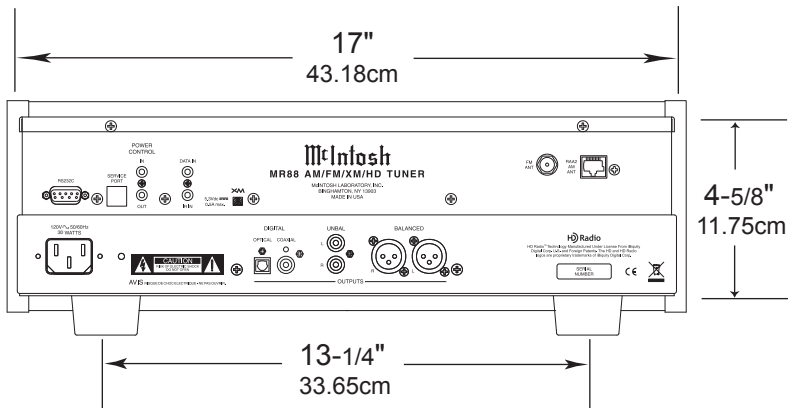

Side View of the MR88

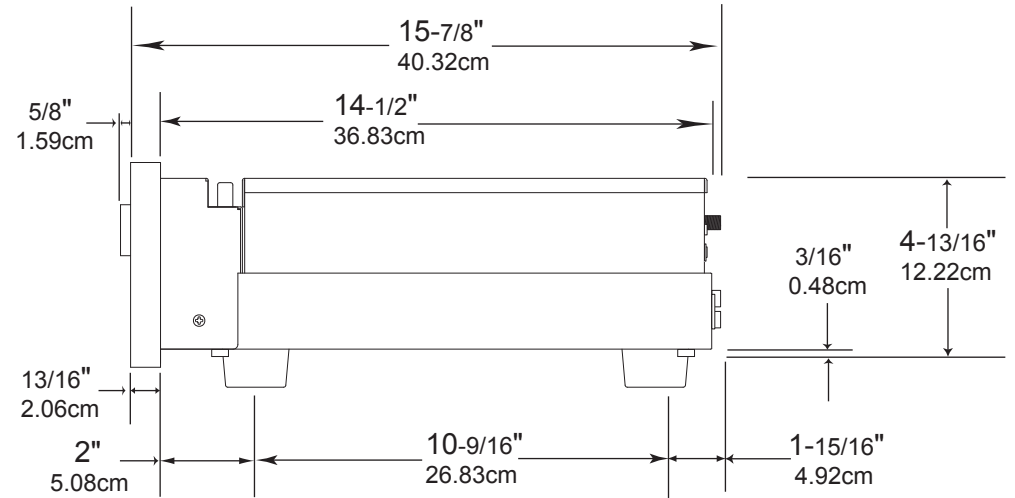

Installation

The MR88 can be placed upright on a table or shelf, standing on its four feet. It also can be custom installed in a piece of furniture or cabinet of your choice. The four feet may be removed from the bottom of the MR88 when it is custom installed as outlined below. The four feet together with the mounting screws should be retained for possible future use if the MR88 is removed from the custom installation and used free standing. The required panel cutout, ventilation cutout and unit dimensions are shown.

Always provide adequate ventilation for your MR88. Cool operation ensures the longest possible operating life for any electronic instrument. Do not install the MR88 directly above a heat generating component such as a high powered amplifier. If all the components are installed in a single cabinet, a quiet running ventilation fan can be a definite asset in maintaining all the system components at the coolest possible operating temperature.

When the MR88 is placed free-standing on a flat surface, allow at least 2 inches (5.08cm) above the top, 2 inches (5.08cm) below the bottom and 2 inches (5.08cm) on each side of the Tuner, so airflow is not obstructed. Allow 19-1/2 inches (49.53cm) depth behind the front panel. Allow 1-7/16 inch (3.66cm) in front of the mounting panel for knob clearance.

A custom cabinet installation should provide the minimum spacing dimensions for cool operation. Allow at least 2 inches (5.08cm) above the top, 2 inches (5.08cm) below the bottom and 2 inches (5.08cm) on each side of the Tuner, so airflow is not obstructed. The Custom Cabinet should be open backed and at least 12 inches (30.48cm) away from any surface such as a wall. Be sure to cut out a ventilation hole in the mounting shelf according to the dimensions in the drawing. Allow 1-7/16 inch (3.66cm) in front of the mounting panel for knob clearance.

**MR88 Front Panel
Custom Cabinet Cutout**

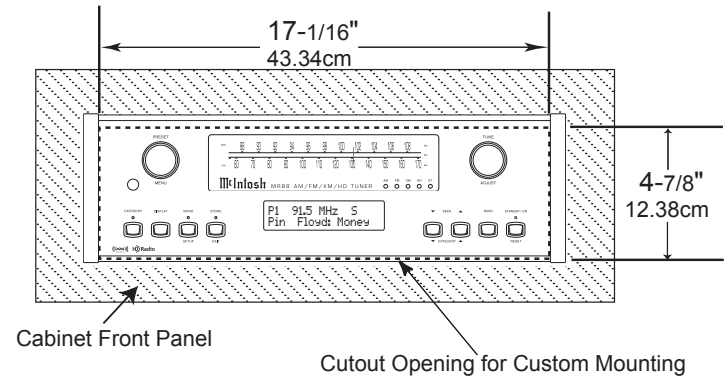

**MR88 Side View
in Custom Cabinet**

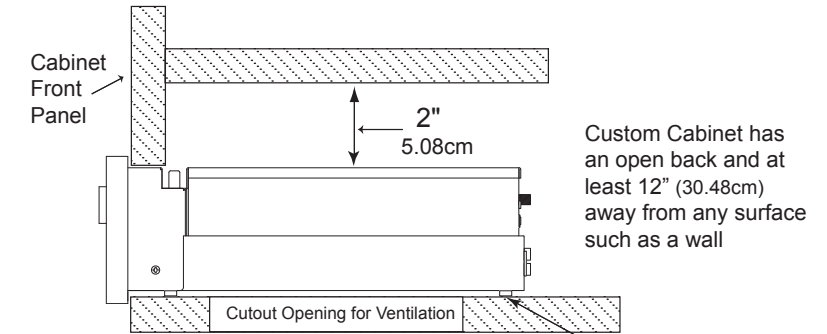

**MR88 Bottom View
in Custom Cabinet**

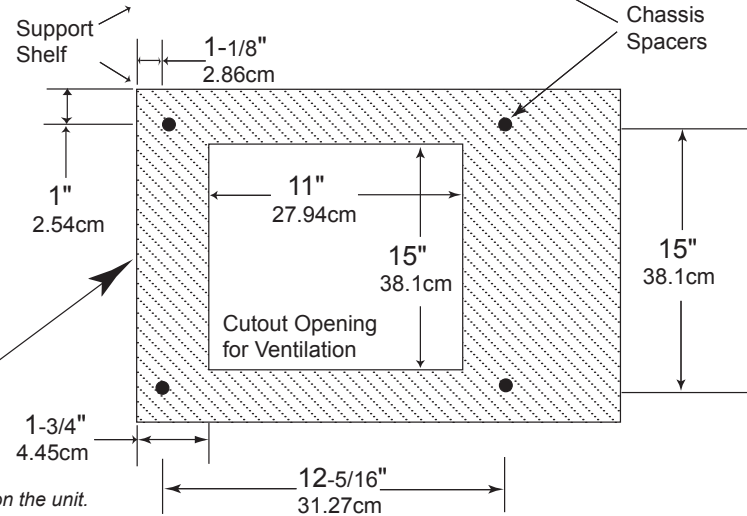

*Note: Center the cutout Horizontally on the unit.
For purposes of clarity, the above illustration is not drawn to scale.*



Rear Panel and RAA2 Connections

RS232 connector for communications with an external control device

POWER CONTROL IN receives signals from a McIntosh component (5-15 Volts ON, 0 Volts OFF). POWER CONTROL OUT sends out (12 Volts ON) signal to another McIntosh Component when the MR88 is On.

DATA IN receives operating data from a McIntosh Preamp or Control Center

75 OHM FM ANT (Antenna) connects to an external FM Antenna or cable

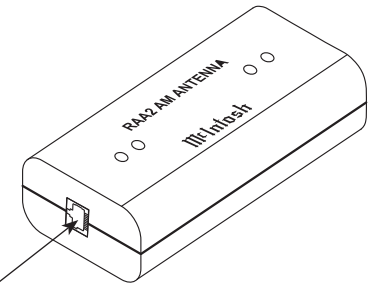

Connect to the RAA2 AM ANT connector on MR88 using the supplied cable

Used for upgrading the MR88 Firmware

IR Input for connecting an IR Receiver

Connects to the XM Mini-Tuner Home Dock

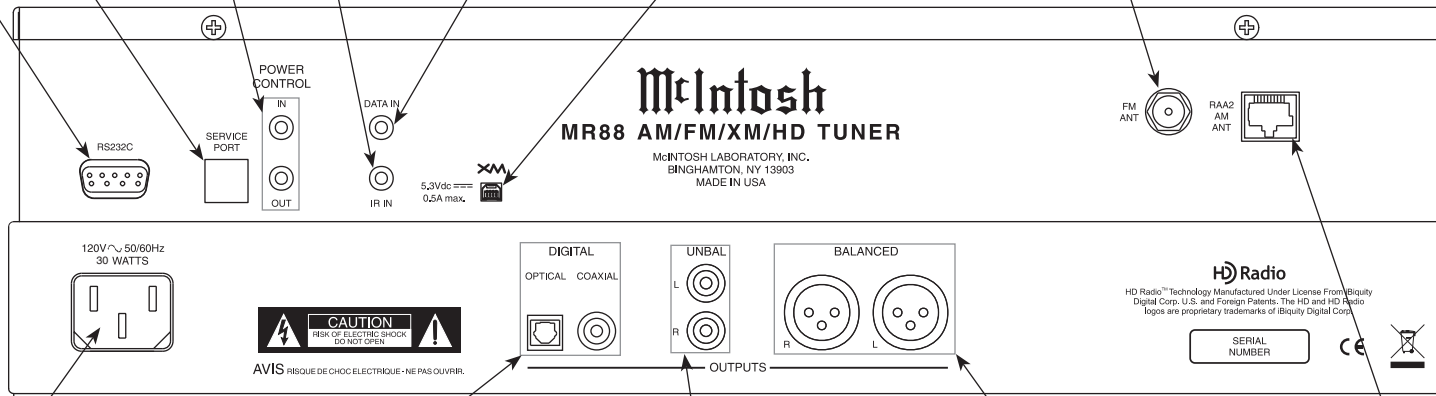

COAXIAL AND OPTICAL DIGITAL AUDIO OUTPUTS send signals to a Preamp or Control Center with a D/A Converter or a decoder

BALANCED AUDIO OUTPUTS supply analog audio signals to Balanced Inputs of other components

UNBALANCED AUDIO OUTPUTS supply analog audio signals to Unbalanced Inputs of other components

AM ANT (Antenna) connector allows a McIntosh RAA2 Remote Antenna to be connected

Connect the MR88 power cord to a live AC outlet. Refer to information on the back panel of your MR88 to determine the correct voltage for your unit

How to Connect Antenna Components

1. Using the supplied shielded cable, connect one end into the RAA2 AM Antenna jack and the other end of the same cable into the MR88 Tuner jack labeled RAA2 AM ANT.

Note: If a longer length cable needs to be used between the MR88 and the RAA2 AM Antenna, use an 8 conductor straight-thru cable with an outer shield and RJ45 connectors on each end (shielded CAT5 or CAT6 patch cable).

2. Connect a 75 ohm coax cable from a FM Antenna or cable system to the MR88, 75 OHM FM ANT Connector.

How to Connect Optional XM Components

1. Connect the XM Antenna cable to the XM Home Dock.
2. Connect the XM Home Dock Cable to the XM Connector on the Rear Panel of the MR88 Tuner.
3. Plug in the XM Mini-Tuner into the XM Home Dock.
4. Refer to instructions supplied with the XM Product for activation procedures and antenna orientation. Also refer to Setup “XM Radio Antenna Aim” on page 18 and “XM Ready® Subscription” on page 24 in this Owner’s Manual.

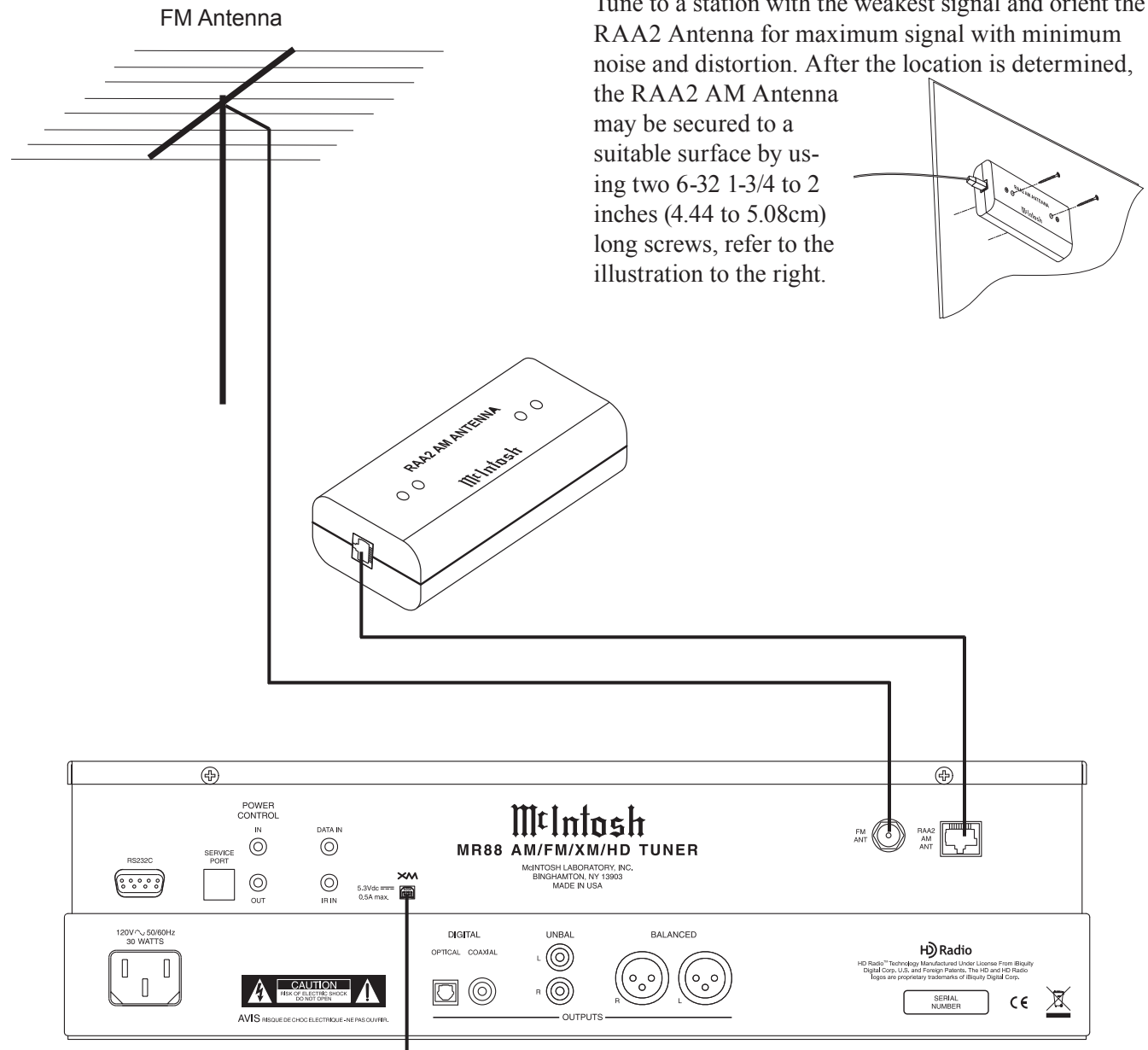
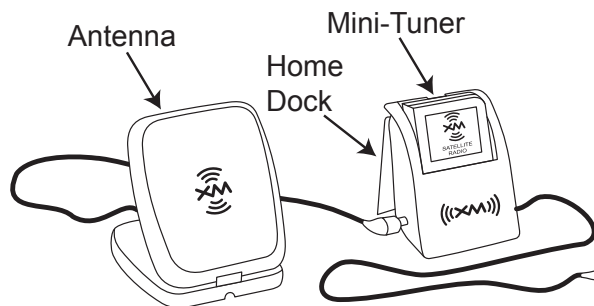

Mounting the RAA2 AM Antenna

Tune to a station with the weakest signal and orient the RAA2 Antenna for maximum signal with minimum noise and distortion. After the location is determined, the RAA2 AM Antenna may be secured to a suitable surface by using two 6-32 1-3/4 to 2 inches (4.44 to 5.08cm) long screws, refer to the illustration to the right.

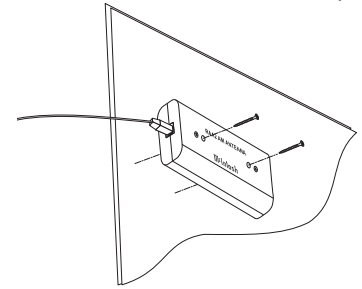



How to Connect the MR88

The MR88 has the ability to be remotely switched On/Off from a McIntosh Preamplifier or A/V Control Center via the Power Control connection. The MR88 Data Port Connection allows for the remote operation of basic functions using the Preamplifier or A/V Control Center Remote Control. With an appropriate IR Sensor connected to the MR88, remote control operation is possible from another room and/or when the MR88 is located in a cabinet with the doors closed.

The connection instructions below, together with the MR88 Connection Diagram located on the opposite page, is an example of a typical audio or audio/video system. Your system may vary from this, however the actual components would be connected in a similar manner. For additional information refer to “Connector and Cable Information” on pages 4 and 5.

Power Control Connections:

1. Connect a Control Cable from the Preamplifier or A/V Control Center to the appropriate (Tuner/ Trigger 4) Power Control (or Trigger) Jack to the POWER CONTROL IN Jack on the McIntosh MR88 Tuner.
2. Optionally, connect a Control Cable from the MR88 Tuner POWER CONTROL OUT jack to the next McIntosh Source Component Power Control In Jack.

Data Control Connections:

3. Connect a Control Cable from the Preamplifier or A/V Control Center to the appropriate (Tuner/ 4) Data Port Out Jack to the McIntosh MR88 Tuner DATA IN Jack.

Sensor Connections:

4. Optionally, connect an appropriate IR Sensor to the McIntosh MR88 Tuner IR IN Jack.

Digital Audio Connections:

5. Optionally, connect a Cable from the McIntosh MR88 Tuner OPTICAL or COAXIAL to the appropriate Optical or Coaxial Input (Tuner/ 9) on the Preamplifier or A/V Control Center.

Note: Coaxial connections may be used instead of the Optical Connections.

6. Optionally, connect a Cable from the McIntosh MR88 Tuner remaining DIGITAL Output to the appropriate Optical or Coaxial Input on another Preamplifier or A/V Control Center.

Analog Audio Connections:

7. Connect Balanced Cables from the McIntosh MR88 Tuner BALANCED OUTPUT Connectors to the appropriate (Tuner/Balanced Audio In 2) Preamplifier or A/V Control Center Balanced Input Connectors.
8. Optionally, connect an Audio Cable from the MR88 Tuner UNBALANCED OUTPUT Jacks to the appropriate (Tuner/Stereo Audio In 4) Preamplifier or A/V Control Center Balanced Input Jacks.

Note: Preamplifiers require either a Balanced or Unbalanced audio connection. A/V Control Centers usually require unbalanced connections for proper operation of Zone B and the record output, with Balanced connections as optional.

AC Power Cords Connections:

9. Connect the McIntosh MR88 Tuner AC Power Cord to a live AC outlet.



A/V Control Center

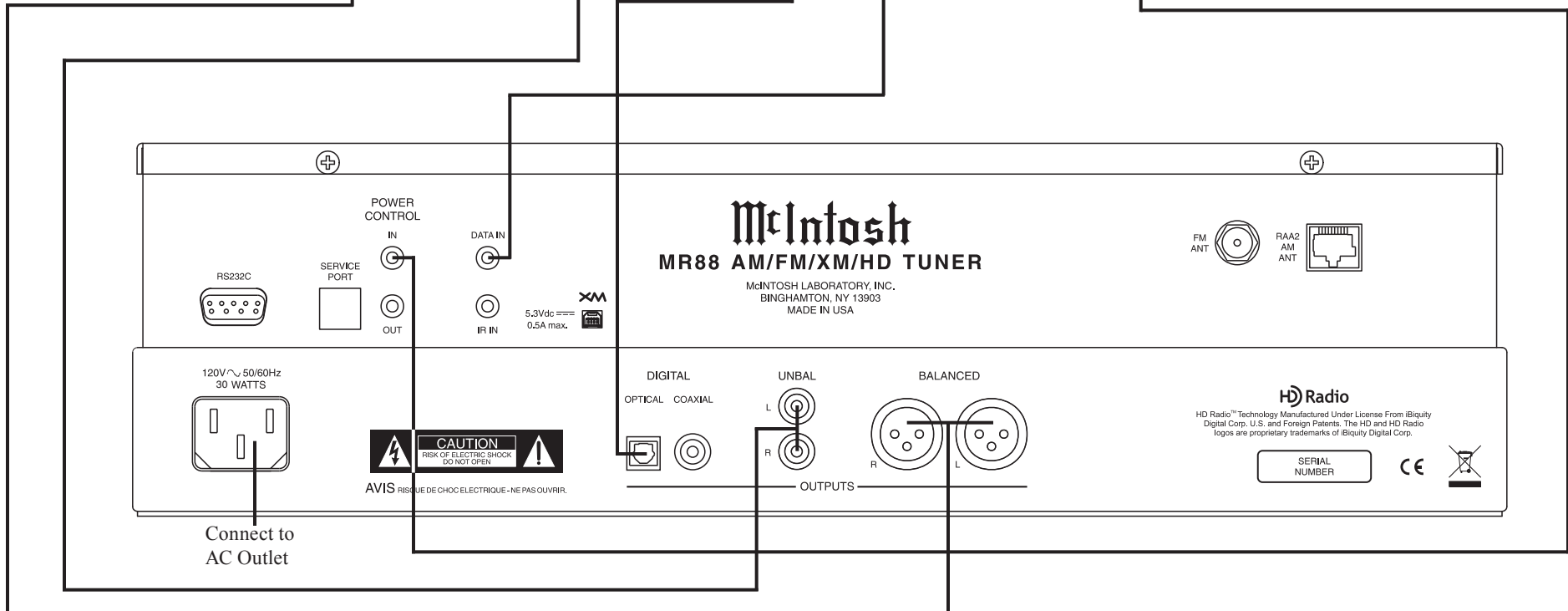
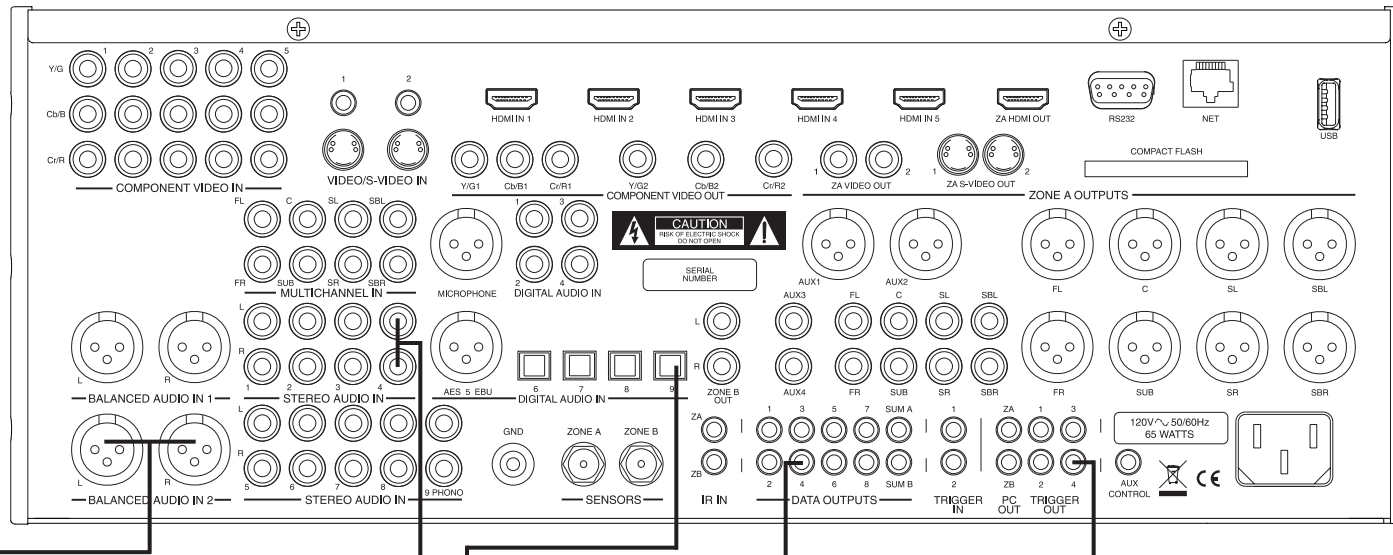

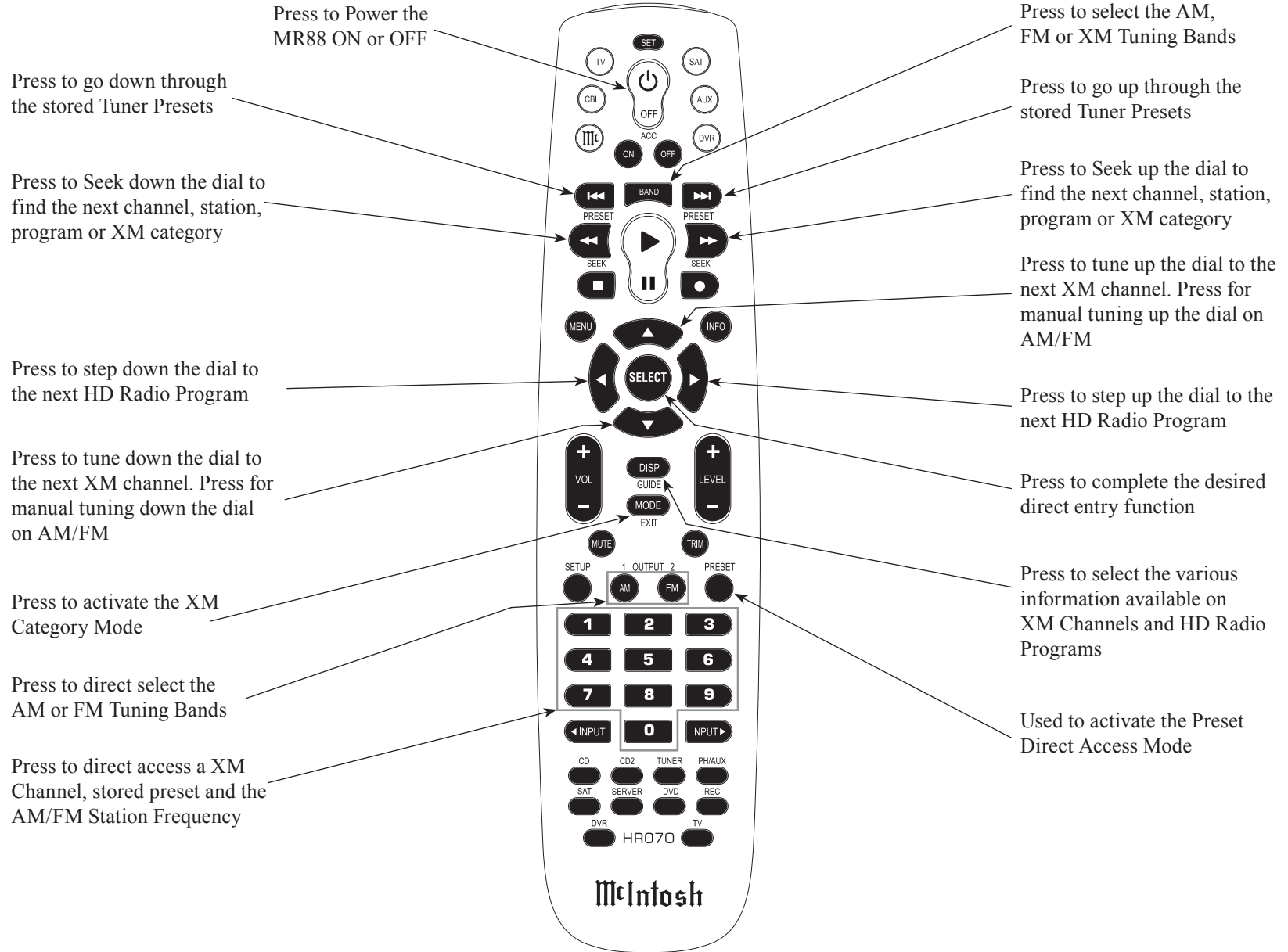

Note: Push-buttons whose function is not identified above are for use with other McIntosh Products.

How to use the Remote Control

The Remote Control is capable of performing basic Operating Functions for the MR88 AM/FM/XM/HD Tuner.

Note: Refer to the "How to Operate" Section of this manual for additional information using this Remote Control, starting on page 20.

Manual Tuning

Use the BAND Push-button to select AM, FM or XM. Press the DIRECTIONAL Up▲ or Down▼ Push-button to move from station to station (AM or FM) or from channel to channel (XM).

Automatic Tuning

Use the BAND Push-button to select AM, FM or XM. Press the SEEK ◀ down or ▶ up the dial Push-button to move to the next station (AM or FM) or to the next channel (XM).

Preset Tuning

Use the BAND Push-button to select AM, FM or XM. Press the PRESET ◀◀ down or ▶▶ up the dial Push-button and the MR88 will stop on the next Station, Program or Channel in Preset Memory.

Note: For information on entering a Channel, Station or Program into memory, refer to pages 21 and 25.

Direct Preset Access

To access the desired Station, Program or Channel previously assigned to a Preset stored in memory, perform the following:

1. Press the BAND Push-button to select AM, FM or XM desired Preset.
2. Press the PRESET Push-button.
3. Using the 0 through 9 numeric Push-buttons enter the Preset Number.

Note: When selecting a Preset 1 through 9 and there are more than ten Presets entered into memory for the given Band (AM, FM or XM) there is a two second delay before the MR88 will go to the single digit Preset.

Direct Station or Channel Access

To access a desired Station or Channel perform the following:

1. Press the BAND Push-button to select AM, FM or XM desired Preset.
2. Using the 0 through 9 numeric Push-buttons enter the Frequency Number of the Station (for AM or FM) or the Channel Number (for XM).

Note: When entering a FM Station, there is no need to enter the decimal point.

Selecting FM HD Radio Programs

To access a desired Program on a FM HD Radio Broadcast perform the following:

1. Press the BAND Push-button to select FM.
2. Using the SEEK ◀ down or ▶ up the dial Push-buttons or the DIRECTIONAL Up▲ or Down▼ Push-button to select the desired HD Station.
3. Once the MR88 Tuner HD indicator illuminates, select the desired Program by using the DIRECTIONAL Left ◀ or Right ▶ Push-buttons.

Selecting XM Category

To access a desired Category on XM perform the following:

1. Press the BAND Push-button to select XM.
2. Press the MODE Push-button to activate the Category Mode.
3. Select the desired Category by using the SEEK ◀ down or ▶ up Push-buttons.

4. Press the DIRECTIONAL Up▲ or Down▼ Push-button to select the desired XM Channel.

CATEGORY Push-button with indicator, selects groups of XM Channels via music/talk genre

PRESET/MENU Control selects for listening or storing the desired radio station, HD Radio Station Program or XM Channel. Also used to select various menus when in the setup mode

Indicates the active Tuning Band AM, FM or XM. Also indicates STEREO and/or HD Radio reception

IR Sensor receives commands from a Remote Control

Electronic Pointer Indicates the FM and AM Station tuning dial location

TUNE/ADJUST Control selects the desired radio station, HD Radio Station Program or XM Channel. Also used to select various items when in the setup mode

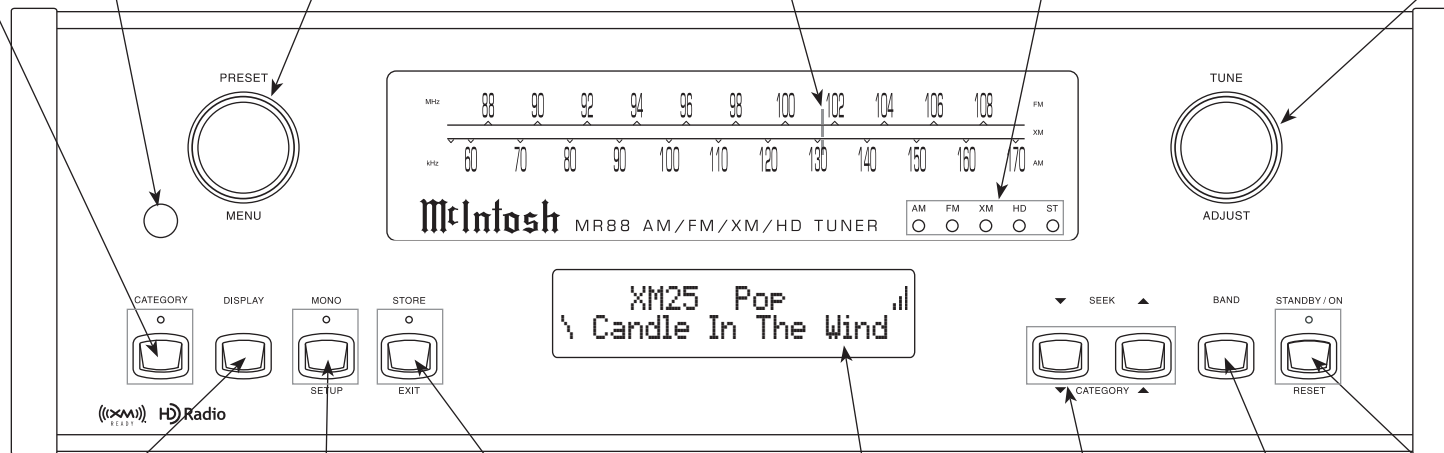

DISPLAY selects from various information such as program type, music format artist/song name and is indicated on the Information Display when tuned to a HD Radio Station or XM Channel

MONO/SETUP Push-button with indicator, combines the Left and Right Channel signals for Monophonic Sound on FM Stations, used to enter/exit the Setup Mode

STORE/EXIT Push-button with indicator, used to enter and clear channels, stations and programs in Preset Memory; it is also used for various functions in the Setup Mode.

INFORMATION DISPLAY indicates various Operational Functions and Setup Mode Settings

SEEK/CATEGORY Push-buttons, used to find the next channel, station or program

BAND Push-button is used to select the AM, FM or XM tuning band

STANDBY/ON Push-button with indicator, switches the MR88 ON or OFF (Standby) and resets the microprocessors

How to Operate the Tuner Setup Mode

Your McIntosh MR88 has been factory configured for default operating settings that will allow immediate enjoyment of superb audio from AM, FM, HD Radio™ Stations and the optional XM Radio without the need for further adjustments. Proceed to “How to Operate the MR88 Tuner” at this time unless you wish to make changes to the MR88 factory default settings.

A Setup Feature is provided to customize the operating settings using the Front Panel Information Display. Refer to the MR88 Front Panel Illustration on the opposite page while performing the following steps.

Note: If the MR88 is currently On, proceed to step 2.

1. Press the STANDBY/ON Push-button to switch On the MR88. The MR88 will go through a brief startup initialization with the Front Panel Information Display indicating the last station, program or channel.

Note: The first time the MR88 is switched On the Tuner will default to the FM Band and is tuned to 87.5MHz.

2. Press the MONO/SETUP Push-button until the Front Panel Information Display indicates McIntosh MR88 V__._ firmware version, refer to figure 1.



Figure 1

The firm-ware version numbers identify the type of operational functioning of the MR88 Tuner. At this time the LEDs above the STORE/EXIT Push-button will be illuminated.

3. Rotate the MENU (PRESET) Control and notice the Setup Mode goes forward through nine different possible adjustment selections and five infor-

mational displays.

4. To exit from the Setup Mode, press the MONO/SETUP Push-button. The LED above the STORE/EXIT Push-button will extinguish and the Front Panel Display will revert back to its normal display. Refer to figure 2.



Figure 2

Default Settings

The Default Settings Chart below indicates the Function Name, Default Setting and the Page Number for additional information.

MR88 Default Settings		
Function Name	Setting	Page no.
McIntosh MR88	V_._	15
Clear Presets	None	15
Dial Brightness	15	15
Display Brightness	3	16
Display Auto Fade	Off	16
Remote IR Sensor	On	16
Remote Power IR	Disable	16
Remote Codes	Norm	17
Comm Port Baud Rate	115,200	17
Tuner SDK	MC_ _ _ _ _ _ _ _ _ _	17
Tuner DSP	DRI- _ _ - _ _ _ _ - _ _	17
HD Radio Blend Mode	Auto	18
XM Tuner	Enable	18
XM Radio ID	_ _ _ _ _ _ _ _	18
Antenna Aim	variable reading	18

Clear Presets

The MR88 AM/FM/XM/HD Tuner has three different Tuning Modes. One of the Tuning Modes is Preset Tuning, where favorite stations are entered into memory for quick recall. Any preset station may be removed from memory at any time. There are times when it may be desirable to remove from memory all or some of the preset stations. To accomplish this perform the following steps:

1. Press the MONO/SETUP Push-button until the Setup Mode is active. Then rotate the PRESET/MENU Control to select Setup Menu item “SETUP: PRESETS”. Refer to figure 3.



Figure 3

2. Rotate the TUNE/ADJUST Control

to select one of five choices:

- NONE (default setting, No Presets are cleared)
- AM (all AM Presets are cleared)
- FM (all FM Presets are cleared)
- XM (all XM Presets are cleared)
- All (all AM, FM and XM Presets are cleared).

Note: The Presets are cleared when the Setup Mode is exited.

3. Proceed to the next Setup Menu Item or press the MONO/SETUP Push-button to exit the Setup Mode. “How to operate the Tuner” starts on page 20.

Dial Brightness

The brightness level of the Dial may be changed from the default setting. To change the brightness perform the following steps:

1. Press the MONO/SETUP Push-button until the Setup Mode is active. Then rotate the PRESET/MENU Control to select Setup Menu item “SET-



Dial Pointer Brightness, con't

UP: DIAL BRIGHTNESS". Refer to figure 4.



Figure 4

2. Rotate the TUNE/ADJUST Control to select the desired brightness. The range of adjustment is from 0 to 20.
3. Proceed to the next Setup Menu Item or press the MONO/SETUP Push-button to exit the Setup Mode. "How to operate the Tuner" starts on page 20.

Information Display Brightness

The brightness level of the Front Panel Information Display may be changed from the default setting. To change the brightness perform the following steps:

1. Press the MONO/SETUP Push-button until the Setup Mode is active. Then rotate the PRESET/MENU Control to select Setup Menu item "SETUP: DISPLAY BRIGHTNESS". Refer to figure 5.



Figure 5

2. Rotate the TUNE/ADJUST Control to select the desired brightness. The range of adjustment is from 1 to 4.
3. Proceed to the next Setup Menu Item or press the MONO/SETUP Push-button to exit the Setup Mode. "How to operate the Tuner" starts on page 20.

Information Display Auto Fade

The Front Panel Information Display Auto Fade Feature may be activated by performing the following steps:

1. Press the MONO/SETUP Push-button until the Setup Mode is active. Then rotate the PRESET/MENU Control to select Setup Menu item "SETUP: DISPLAY AUTO FADE". Refer to figure 6.



Figure 6

2. Rotate the TUNE/ADJUST Control to select ON. Approximately 17 seconds after there is no change to the operating function (Front Panel or Remote Control), the Front Panel Information Display will blank out until an operating function is accessed.
3. Proceed to the next Setup Menu Item or press the MONO/SETUP Push-button to exit the Setup Mode. "How to operate the Tuner" starts on page 20.

Remote IR Sensor

When an external IR Sensor is connected to the MR88 and located in the same room as the tuner, it is advisable to disable the built-in IR Sensor located on the Front Panel. Disable the sensor by performing the following steps:

1. Press the MONO/SETUP Push-button until the Setup Mode is active. Then rotate the PRESET/MENU Control to select Setup Menu item "SETUP: REMOTE IR SENSOR". Refer to figure 7.
2. Rotate the TUNE/ADJUST Control to select OFF.



Figure 7

3. Proceed to the next Setup Menu Item or press the MONO/SETUP Push-button to exit the Setup Mode. "How to operate the Tuner" starts on page 20.

Remote Control Power Command

In a typical audio system, the MR88 switches On and Off with the McIntosh Preamplifier or A/V Control Center when a Power Control Connection is made between the units. When the MR88 is used alone, it can be switched On or Off using the Push-button on the MR88 Remote Control. To activate the Remote Control On/Off feature perform the following steps:

1. Press the MONO/SETUP Push-button until the Setup Mode is active. Then rotate the PRESET/MENU Control to select Setup Menu item "SETUP: REMOTE POWER IR". Refer to figure 8.



Figure 8

2. Rotate the TUNE/ADJUST Control to select ENABLE.
3. Proceed to the next Setup Menu Item or press the MONO/SETUP Push-button to exit the Setup Mode. "How to operate the Tuner" starts on page 20.

Remote Control Codes

The Remote Control included with the MR88 utilizes the NORMal McIntosh Control Codes. The Second Set of Control Codes the MR88 will respond to is referred to as the ALternate Codes. The ALternate Codes are used when the MR88 is used in the same location as a McIntosh Preamplifier and/or A/V Control Center. This will prevent the Remote Control from affecting the operation of both units at the same time. To activate the Remote Control ALternate Codes perform the following steps:

1. Press the MONO/SETUP Push-button until the Setup Mode is active. Then rotate the PRESET/MENU Control to select Setup Menu item "SETUP: REMOTE CODES". Refer to figure 9.

2.

SETUP: REMOTE
CODES: NORM

Figure 9

Rotate the TUNE/ADJUST Control to select ALT.

3. To change the MR88 Remote Control to the Alternate Codes perform the following steps:

- A. Press the "Mc" Push-button.
- B. Press the SET Push-button until the "Mc" Push-button flashes twice.
- C. Press the 3, 2, 4, 2 and 9 Push-buttons within 5 seconds.
- D. The "Mc" Push-button flashes twice.

Note: To reset the Remote Control to normal codes perform steps A and B then enter 3, 2, 4, 2 and 8 for step C.

4. Press the MONO/SETUP Push-button to exit the Setup Mode. Press the BAND Push-button on the Remote Control to verify proper operation.
5. Proceed to the next Setup Menu Item or "How to operate the Tuner" starts on page 20.

Comm Port Baud Rate

The MR88 may be remotely controlled from other equipment connected to the Rear Panel RS232C connector. The speed at which the MR88 communicates with other equipment is adjustable from 9,600 bits per second to 115,200 bits per second. To change from the default speed of 115,200 bits per second, perform the following steps:

1. Press the MONO/SETUP Push-button until the Setup Mode is active. Then rotate the PRESET/MENU Control to select Setup Menu item "SETUP: COMM PORT BAUD RATE". Refer to figure 10.

SETUP: COMM PORT
BAUD RATE: 115200

Figure 10

2. Rotate the TUNE/ADJUST Control to select the desired speed.
3. Proceed to the next Setup Menu Item or press the MONO/SETUP Push-button to exit the Setup Mode. "How to operate the Tuner" starts on page 20.

Tuner SDK

The MR88 Tuner SDK Firmware version may be checked by performing the following steps:

1. Press the MONO/SETUP Push-button until the Setup Mode is active. Then rotate the PRESET/MENU Control to select Setup Menu item "SETUP: HD TUNER SDK". Refer to figure 11.

SETUP: HD TUNER SDK
MC

Figure 11

2. Proceed to the next Setup Menu Item or press the MONO/SETUP Push-button to exit the Setup Mode. "How to operate the Tuner" starts on page 20.

Tuner DSP

The MR88 Tuner DSP Firmware version may be checked by performing the following steps:

1. Press the MONO/SETUP Push-button until the Setup Mode is active. Then rotate the PRESET/MENU Control to select Setup Menu item "SETUP: HD TUNER DSP". Refer to figure 12.

SETUP: HD TUNER DSP
DRI

Figure 12

2. Proceed to the next Setup Menu Item or press the MONO/SETUP Push-button to exit the Setup Mode. "How to operate the Tuner" starts on page 20.

HD Radio Blend Mode

The MR88 BLEND MODE allows selection of the different signal types received from AM and FM Broadcast Stations. Conventional Radio Broadcast Signals contain Analog Audio Information only. A HD Radio™ Broadcast Signal includes both Analog Audio Information and Digital Audio Information. The Tuners Blend Mode may be changed from the default setting of AUTO to either ANALOG only or DIGITAL only audio information. In the AUTO Blend Mode the Tuner Audio Output can vary between the transmitted Analog Audio only, the transmitted decoded Digital Audio only or a blending of the two. This blending produces the best possible sound quality even with varying reception conditions. To change from the default setting of AUTO perform the following steps:

1. Press the MONO/SETUP Push-button until the Setup Mode is active. Then rotate the PRESET/MENU Control to select Setup Menu item “SETUP: HD TUNER Blend Mode: AUTO”. Refer to figure 13.

Figure 13

2. Rotate the TUNE/ADJUST Control to select either Analog (only) or Digital (only).
3. Proceed to the next Setup Menu Item or press the MONO/SETUP Push-button to exit the Setup Mode. “How to operate the Tuner” starts on page 20.

XM Tuner

Selection of the XM Band may be switched off when the optional XM Mini-Tuner is not connected to the MR88 Tuner, by performing the following steps:

1. Press the MONO/SETUP Push-button until the Setup Mode is active. Then rotate the PRESET/MENU Control to select Setup Menu item “SETUP: XM TUNER Enable”. Using the TUNE/ADJUST Control select “SETUP: XM TUNER Disable”, refer to figure 14A.

Figure 14A

2. Press the MONO/SETUP Push-button to exit the Setup Mode. The MR88 Tuner will now switch Power OFF to process the change.

Note: To reactivate XM Operations on the MR88 Tuner perform step 1 and select “Enable”. Then perform step 2.
3. Press the STANDBY/ON Push-button to switch Power ON to the MR88. Press the MONO/SETUP Push-button to re-enter the Setup Mode or proceed to “How to operate the Tuner” starting on page 20.

Note: The following XM Setup Modes are only available when a XM Mini-Tuner is connected to the MR88 and the XM Band was selected before entering the Setup Mode.

XM Radio ID

The XM Mini-Tuner Module ID Number may be checked at any time by performing the following steps:

1. Press the MONO/SETUP Push-button until the Setup Mode is active. Then rotate the PRESET/MENU Control to select Setup Menu item “SETUP: XM RADIO ID”. Refer to figure 14B.

Figure 14B

2. Proceed to the next Setup Menu Item or press the MONO/SETUP Push-button to exit the Setup Mode. “How to operate the Tuner” starts on page 20.

XM Radio Antenna Aim

The MR88 Front Panel Information Display will indicate the signal strength of the received XM Radio Satellite and Terrestrial Signals on the Front Panel Information Display. This can assist in the positioning of the XM Antenna for the best reception. Check the signal strength by performing the following steps:

1. Press the MONO/SETUP Push-button until the Setup Mode is active. Then rotate the PRESET/MENU Control to select Setup Menu item “SETUP: ANTENNA AIM”. Refer to figure 15.

Figure 15

The more columns and column segments illuminated after display colon, the stronger the signal. In certain reception areas a Terrestrial signal might replace or supplement the Satellite Signal.

2. Proceed to the next Setup Menu Item or press the MONO/SETUP Push-button to exit the Setup Mode. “How to operate the Tuner” starts on page 20.

Note: The XM Setup Modes appearing after the “XM Radio Antenna Aim” Mode are for XM Diagnostic purposes. Refer to pages 28-29.





How to Operate

The McIntosh MR88 AM/FM/XM HD Tuner incorporates an advanced design AM/FM/XM Tuner with many desirable performance features to enhance your enjoyment of radio broadcasts. Reception of XM is optional. It requires a XM Antenna, XM Home Dock, XM Mini-Tuner and a XM Monthly Service Subscription. Contact your McIntosh Dealer for additional information.

Power On

Press the STANDBY/ON Push-button on the Front Panel or the  (Power) Push-button on the Remote Control. Refer to figures 16 and 25. The MR88 will go through a brief startup initialization with the Front Panel Information Display indicating the last Station, Program on a HD Radio Station or XM Channel.

Note: The first time the MR88 is switched On the Tuner will default to the FM Band and is tuned to 87.5MHz.

Band Selection

Press the BAND Push-button on the Front Panel or Remote Control to select either AM, FM or XM.

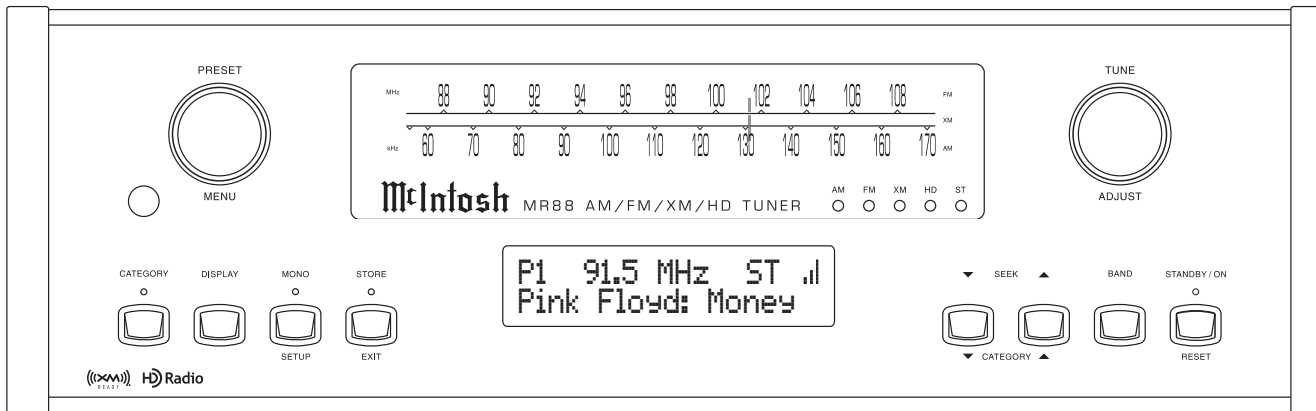

Figure 16

There are LEDs located in the MR88 Dial Glass Window to indicate which Band is active. There are also LEDs to indicate when a received radio broadcast is Stereo and/or HD Radio Signal. Several seconds after the AM or FM Band is selected, the Front Panel Information Display will change to indicate the frequency the tuner is currently tuned to. Refer to figure 16.

Tuning Broadcasts

There are three Tuning methods for selection of AM, FM or XM Broadcasts as follows:

1. MANUAL - Allows Manual Tuning of available AM, FM and XM broadcasts.
2. SEEK - Automatic Tuning of available AM, FM and XM broadcasts.
3. PRESET - Selection of AM, FM and XM broadcasts entered into memory.

Manual Tuning

Rotate the TUNE/ADJUST Knob counter-clockwise or clockwise to the desired broadcast. For AM and FM broadcasts the Electronic Dial Pointer and Dial Glass Graduations will indicate the approximate Station

Frequency. It will also indicate the locations of HD Radio Programs and a XM Channels. The Front Panel Information Display will indicate the exact Broadcast Frequency and if the Station is transmitting in Stereo and/or HD Radio Signal.



Figure 17



Figure 18







Figure 19

On the right side of the Front Panel Information Display, the vertical columns indicate the relative signal strength of the received Station or Channel. Refer to figures 17, 18 and 19.

When manually tuning a XM Broadcast, the Front Panel Information will indicate the XM Channel number tuned to. Refer to figure 19.

Seek Tuning

The SEEK Tuning Mode (Automatic Tuning) searches the AM, FM or XM Broadcast Bands for available Stations/HD Radio Programs/XM Channels. To use the SEEK Tuning Mode, press and release the SEEK Up  or Down  Push-buttons on the Front Panel to go up or down the dial; or use the SEEK  down or SEEK  up the dial Push-buttons on the Remote Control. Refer to Figures 16 and 25. The MR88 Tuner will automatically stop on the next Station/HD Radio Program/XM Channel.

Note: If the signal strength of a Station/Channel is very weak SEEK Tuning will not stop.

Preset Tuning

The MR88 allows for presetting 20 AM/20 FM Stations/Programs and 20 XM Channels into memory for rapid recall without having to manually tune through unwanted Broadcasts. By rotating the PRESET/MENU Control, a Preset may be selected. Initially, when the AM or FM Broadcast Bands are selected the Front Panel Information Display will indicate “NO PRESETS STORED”. Refer to figure 20.

Note: By default all of the XM Presets are assigned to XMI, the XM Preview Channel.



Figure 20

Creating Presets

Tune to a Station/Program/Channel to be entered into memory either by Manual Tuning or Seek Tuning and then perform the follow steps:

1. Momentarily press and release the Front Panel STORE Push-button. The Front Panel Information Display will indicate “PRESET 1: AVAILABLE”, which is the first of 20 Preset Numbers to be assigned. Refer to figure 21. The Station/Program/Channel to be entered into memory may also be assigned to a different Preset Number (2-20) by rotating the PRESET/MENU Control to select the desired Preset Number.

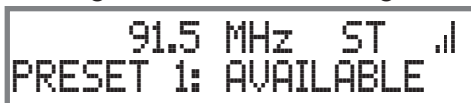

Figure 21

Notes: 1. Presets are automatically assigned in order from 1 to 20 unless a different Preset Number is selected.

2. To exit without entering a new Preset into memory, momentarily press the Front Panel EXIT (STORE) Push-button.

2. To enter a Station/Program/Channel into memory press and hold in the STORE Push-button until the Front Panel Information Display indicates “PRESET STORED” then release the STORE Push-button. Refer to figure 22.

The just entered Preset will be assigned



Figure 22

Preset Number 1 (or the Preset number you selected) and is displayed on the Front Panel Information Display. Refer to figure 23.

3. Assign additional Station/Program/Channel Presets by performing steps 1 and 2.

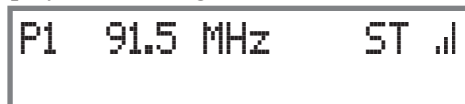

Figure 23

Note: If all 20 Presets are assigned and the STORE Push-button is pressed, the display will indicate the Station/Program/Channel selected for Preset Number 1. Refer to figure 24.

4. To verify the Preset(s) just entered into memory,

rotate the Front Panel PRESET/MENU

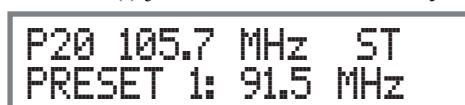

Figure 24

Control or use the PRESET ►► or PRESET ◄◄ Push-buttons on the Remote Control.

Clearing Presets

5. Select the Preset to be removed by using the Front Panel PRESET/MENU Control or by using the PRESET ►► or PRESET ◄◄ Push-buttons on the Remote Control.
6. Press and hold in the Front Panel STORE Push-button until the Front Panel Information Display indicates “PRESET CLEARED” then release the STORE Push-button. Refer to figure 26.

Notes: 1. To exit without clearing a Preset from memory, momentarily press the Front Panel EXIT (STORE) Push-button.

2. If you wish to replace an already assigned Station Preset with another radio Station/Program/Channel, it is not neces-

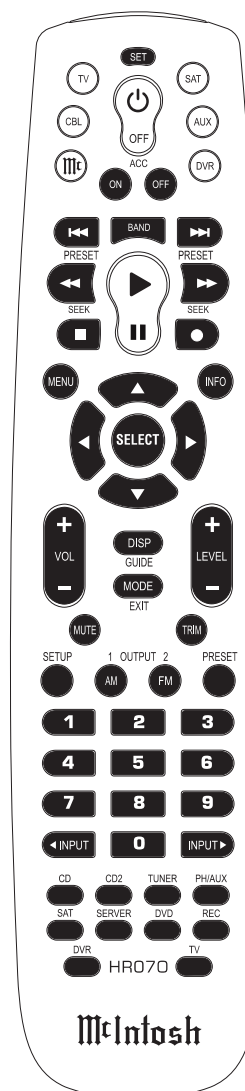

Figure 25



Figure 26



How to Operate, con't

sary to clear the Preset first, just enter in the new Station/Program/Channel for that Preset. The new Station/Program/Channel will automatically replace the previously assigned Station/Program/Channel.

7. To clear any additional Station Presets perform steps 5 and 6 again.

After the creation of Preset(s), use the Front Panel PRESET/MENU Control to select the desired Station/Program/Channel Preset or by using the Remote Control, PRESET ►► or PRESET ◄◄ Push-buttons. Direct access is also possible by pressing the PRESET Push-button followed by entering the number of Preset using the 0-9 numeric Push-buttons on the Remote Control.

Stereo/Mono Mode

The MR88 Tuner automatically switches between Stereo and Monaural FM Broadcasts. When a Stereo FM Broadcast is received, the “ST” LED behind the dial glass will illuminate and the Front Panel Information Display indicates the Stereo Mode by the letters “ST”.

To change the reception mode to MONO press and release the Front Panel MONO Push-button to combine left and right stereo signals to a FM Monophonic signal. The LED above the MONO Push-button will illuminate. Refer to figure 27.

RBDS Text Information

The MR88 Tuner supports display of RBDS (Radio Broadcast Data Service) text from many FM radio Stations/Programs/Channels. When available from a FM Broadcast Station, the text information appears on the second line of the Front Panel Information Display. It may also scroll from right to left, this is for information not possible to display at the same time. This information may include some or all of the following:

- A. Station Call Letters and/or Frequency.
- B. Type of Program and/or music format.
- C. Name of the Artist.
- D. Name of the Song.

The Type of Program and/or music format may be recalled at any time by pressing the DISPLAY Push-button on the Front Panel or by pressing the DISPLAY Push-button on the Remote Control. Refer to figure

25. Also refer to figures 28, 29, 30 and 31 for examples of RBDS Text Information.



Figure 28

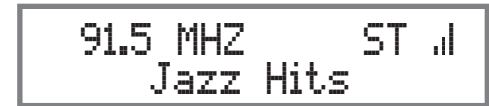

Figure 29

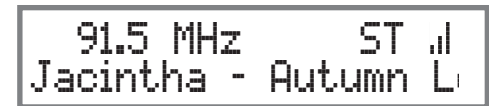

Figure 30

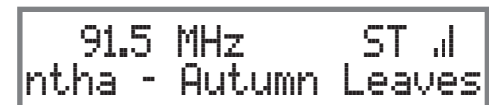

Figure 31

Note: Reception of a weak broadcast signal sending out Text Information might result in an interruption of the text information and/or incorrect characters displayed. If this occurs, try re-orienting the FM Antenna and/or replacing the antenna with an improved reception model. See your McIntosh Dealer for assistance.

HD Radio Reception

Tuning to a HD Radio Station on the MR88 is the same as tuning to any AM or FM Broadcast. Once the MR88 is tuned to a HD Radio Station Broadcast several benefits are immediately apparent. First, there is the improvement in sound fidelity and sonic imaging. Second, many Stations will offer the choice of listening to Multiple Programs. Lastly, most HD Radio Stations send out Text Information which is displayed on the Front Panel of the MR88.

When tuned to a HD Radio Station, the HD” LED behind the dial glass will illuminate and the Front

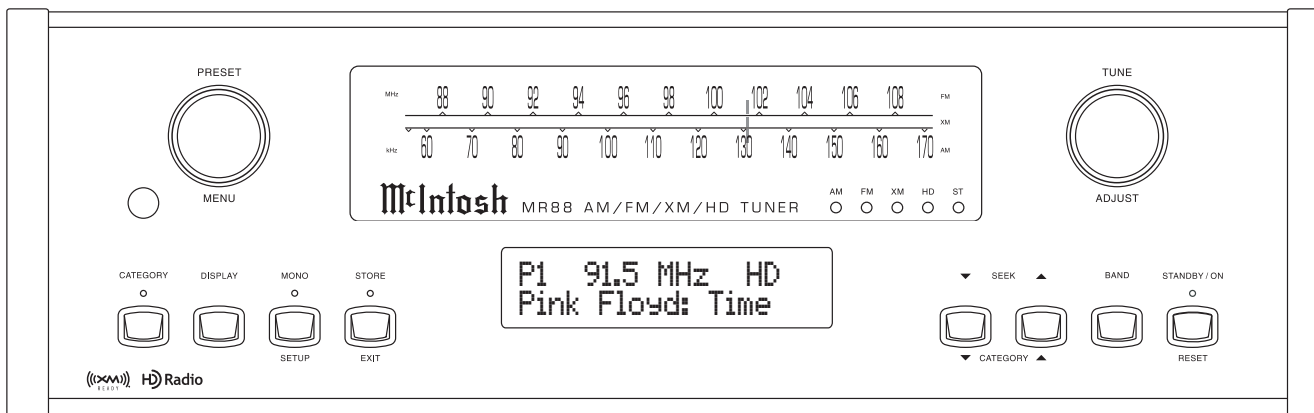

Figure 27

Panel Information Display also indicates HD1. Refer to figure 32. Shortly there after the Texting information will appear on the



Front Panel Information Display. Refer to figures 33 and 34. The



Front Panel Display will also indicate the number of the program selected with the number to the right of "HD"; example, "HD1", "HD2", "HD3" etc. When the Station is sending out more than one program, the Front Panel Display will also indicate an arrow to the right side of "HD1" when the first program is selected and there are additional programs above the program currently selected. An additional arrow on the left side of "HD" will appear when there are programs available below the program currently selected. Refer to figures 35, 36, 37 and 38.



of the program selected with the number to the right of "HD"; example, "HD1", "HD2", "HD3" etc. When the Station is sending out more than one program, the Front Panel Display will also indicate an arrow to the right side of "HD1" when the first program is selected and there are additional programs above the program currently selected. An additional arrow on the left side of "HD" will appear when there are programs available below the program currently selected. Refer to figures 35, 36, 37 and 38.



of the program selected with the number to the right of "HD"; example, "HD1", "HD2", "HD3" etc. When the Station is sending out more than one program, the Front Panel Display will also indicate an arrow to the right side of "HD1" when the first program is selected and there are additional programs above the program currently selected. An additional arrow on the left side of "HD" will appear when there are programs available below the program currently selected. Refer to figures 35, 36, 37 and 38.



of the program selected with the number to the right of "HD"; example, "HD1", "HD2", "HD3" etc. When the Station is sending out more than one program, the Front Panel Display will also indicate an arrow to the right side of "HD1" when the first program is selected and there are additional programs above the program currently selected. An additional arrow on the left side of "HD" will appear when there are programs available below the program currently selected. Refer to figures 35, 36, 37 and 38.

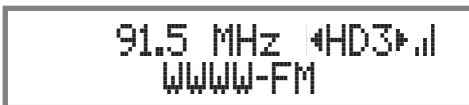

of the program selected with the number to the right of "HD"; example, "HD1", "HD2", "HD3" etc. When the Station is sending out more than one program, the Front Panel Display will also indicate an arrow to the right side of "HD1" when the first program is selected and there are additional programs above the program currently selected. An additional arrow on the left side of "HD" will appear when there are programs available below the program currently selected. Refer to figures 35, 36, 37 and 38.

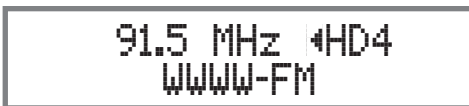

of the program selected with the number to the right of "HD"; example, "HD1", "HD2", "HD3" etc. When the Station is sending out more than one program, the Front Panel Display will also indicate an arrow to the right side of "HD1" when the first program is selected and there are additional programs above the program currently selected. An additional arrow on the left side of "HD" will appear when there are programs available below the program currently selected. Refer to figures 35, 36, 37 and 38.

Figure 38/

To select HD Radio Station Programs perform one of the methods below, after the Front Panel Display indicates HD1 with an arrow. Refer to figure 35.

Manual HD Radio Program Selection

1. Rotate the TUNE/ADJUST Control to select the desired program from the HD Radio Broadcast or press the Right▶ or Left◀ directional Push-buttons on the Remote Control.

Note: A HD Radio Station Program may be assigned to a Preset (stored in memory) by pressing and holding in the STORE Push-button until the Front Panel Information Display indicates "PRESET STORED", then release the STORE Push-button.

Selecting HD Radio Program Preset

2. Select the HD Radio Program Preset by using the Front Panel PRESET/MENU Control or using the Remote Control PRESET ▶▶ or PRESET ◀◀ Push-buttons.

Automatic Selection of HD Radio Program

3. Press and release the SEEK Up▲ or Down▼ Push-buttons on the Front Panel to go up or down the dial; or use the SEEK ◀◀ down or SEEK ▶▶ up the dial Push-buttons on the Remote Control. The MR88 Tuner will automatically stop on the next HD Radio Station Program.

Reset of Microprocessors

In the unlikely event the controls of the MR88 stop functioning, the microprocessors can be reset by performing the following:

1. Press and hold in the STANDBY/ON Push-button for approximately five seconds and then release the push-button.
2. Press the STANDBY/ON Push-button, the MR88 will resume normal operation.

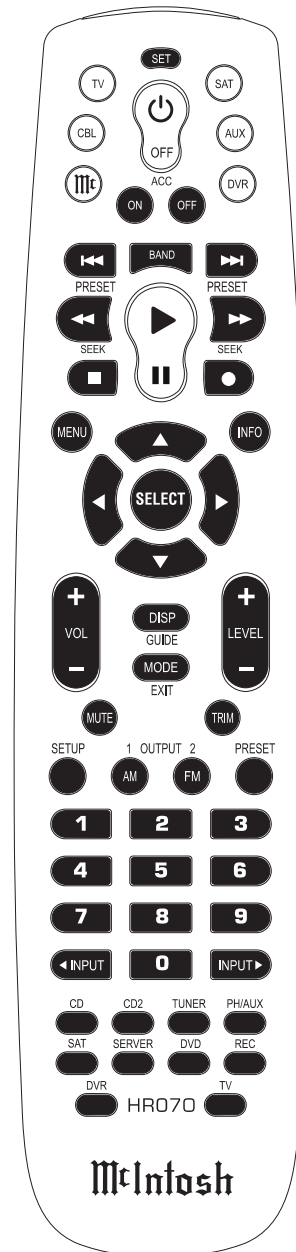

Figure 25



XM Radio Operation

XM Ready® Subscription

Once you have installed the XM Mini-Tuner Home Dock, inserted the XM Mini-Tuner, connected the XM Mini-Tuner Home Dock to your XM Ready® audio system, and installed the antenna, you are ready to subscribe and begin receiving XM programming. There are three places to find your eight character XM Radio ID: On the XM Mini-Tuner, on the XM Mini-Tuner package, and on XM Channel 0. Record the Radio ID below for reference.



Note: The XM Radio ID does not use the letters “I”, “O”, “S” or “F”.

Activate your XM Satellite Radio service in the U.S. online at <http://activate.xmradio.com> or call 1-800-XMRADIO (1-800-967-2346). Activate your XM Satellite Radio service in Canada online at <https://activate.xmradio.ca> or call 1-877-GET-XMSR (1-877-438- 9677). You will need a major credit card. XM will send a signal from the satellites to activate the

full channel lineup. Activation normally takes 10-15 minutes, but during peak busy periods you may need to keep your XM Ready audio system on for up to an hour. When you can access the full lineup on your XM Ready audio system you are done.

XM Radio Channel Selection

With the addition of the optional XM Radio, the MR88 provides additional sources of commercial free music playing, exclusive concerts, original music series, sports coverage, breaking news, up to date weather forecasts and the biggest names in entertainment. Add to that superb sound quality, freedom from interference and over 170 channels to choose from.

The MR88 has four methods for XM Radio Channel selection. The first three selection methods are identical to tuning in an AM/FM Broadcast Station and the fourth method is Category Selection and is exclusive to XM Radio:

1. MANUAL - Allows Manual Tuning of available XM broadcasts.
2. SEEK - Automatic Tuning of available XM broadcasts.
3. PRESET - Selection of XM broadcasts entered into memory.
4. CATEGORY - Selection of Channels using the Category Tuning Mode.

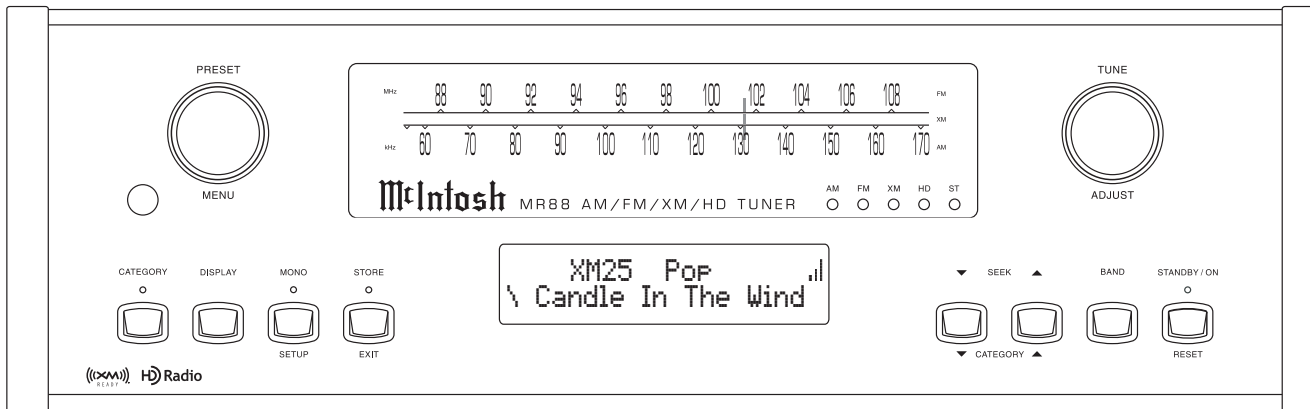

Figure 39

Manual Tuning

Rotate the TUNE/ADJUST Knob counter-clockwise or clockwise to the desired XM Channel. Refer to figure 39. The Electronic Dial Pointer and Dial Glass Center Portion will indicate the approximate location of the XM, Channel 0 located on the far left side of the dial and Channel 247 on the far right side of the dial. The Front Panel Information Display will indicate the Channel Number and the Category of Programming available on the Channel. On the right side of the Front Panel Information Display the vertical columns indicate the relative signal strength of the received Channel. Refer to figure 40. When first tuned to a channel the Front Panel Information Display might indicate “No Signal” momentarily until the MR88 has started to process the Digital Signal. Refer to figure 41. During the time the Digital Signal is being processed the Front Panel Information Display might indicate “Loading”.



Figure 40

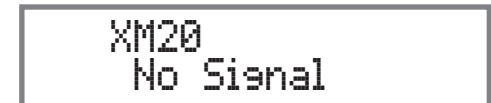

Figure 41



Figure 42

Refer to figure 42. During the time the Digital Signal is being processed the Front Panel Information Display might indicate “Loading”.



XM Radio Operation, con't

- Assign additional Channel Presets by performing steps 1 and 2.

Note: If all 20 Presets are assigned and the STORE Push-button is pressed, the display will indicate the Channel selected for Preset Number 1. Refer to figure 47.



Figure 47

- To verify the Preset(s) just entered into memory, rotate the Front Panel PRESET/MENU Control or use the PRESET ►► or PRESET ◄◄ Push-buttons on the Remote Control.

Clearing Presets

- Select the Preset to be removed by using the Front Panel PRESET/MENU Control or by using the PRESET ►► or PRESET ◄◄ Push-buttons on the Remote Control.
- Press and hold in the Front Panel STORE Push-button until the Front Panel Information Display indicates “PRESET CLEARED” then release the STORE Push-button. Refer to figure 48.



Figure 48

- Notes:*
- To exit without clearing a Preset from memory, momentarily press the Front Panel EXIT (STORE) Push-button.
 - If you wish to replace an already assigned Channel Preset with another XM-Channel, it is not necessary to clear the Preset first, just enter in the new Channel for that Preset. The new Channel will automatically replace the previously assigned Channel.

- To clear any additional Channel Presets perform steps 5 and 6 again.

After the creation of Preset(s), use the Front Panel PRESET/MENU Control to select the desired Channel Preset or use the Remote Control PRESET ►► or PRESET ◄◄ Push-buttons. Direct access is also possible by pressing the PRESET Push-button followed by entering the number of Preset using the 0-9 numeric Push-buttons on the Remote Control.

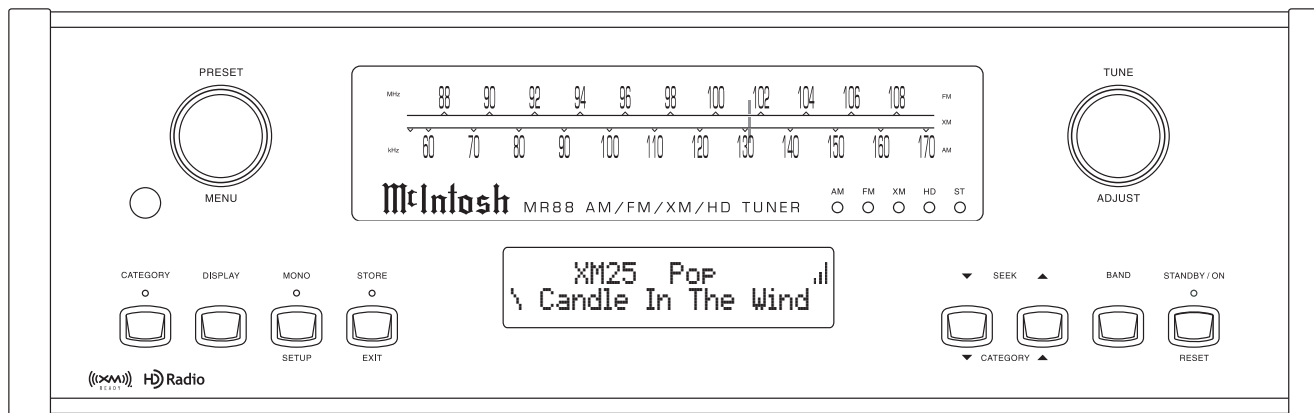

Figure 39

Category Tuning

The Category Tuning on the MR88 allows for selection of XM Channels with similar type of music (Pop, Rock, Jazz, Classical, etc.) or program type such as (Sports, Talk Shows, Traffic, etc.). Perform the following steps to use Category Tuning:

- Press the Front Panel CATEGORY Push-button or the MODE Push-button on the Remote Control. Refer to figures 39 and 25. The LED above the CATEGORY Push-button will illuminate. The Second Row of the Front Panel Information Display will now indicate the current music/program type. Refer to figure 49.



Figure 49

- Press the Front Panel CATEGORY/SEEK Up▲ or Down▼ Push-buttons or use the SEEK ◄ down or SEEK ► up the dial Push-buttons on the Remote Control to select the desired Category Type. Refer to figure 50.



Figure 50

- Once the Category has been selected, either use the Front Panel TUNE/ADJUST Control or the Up▲ or Down▼ directional Push-buttons on the Remote Control to select the desired XM Channel within the selected Category Type. Refer to figures 51 and 52.

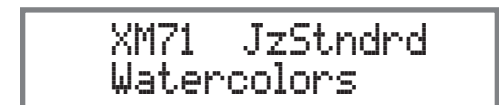

Figure 51



Figure 52

The MR88 Front Panel Information Display will then return to indicating the Artist Name and Song Title on the second line. Refer to figure 53.



Figure 53

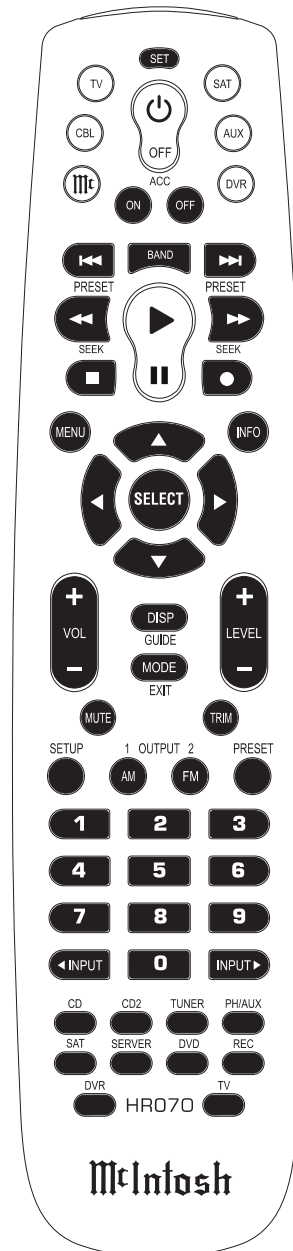
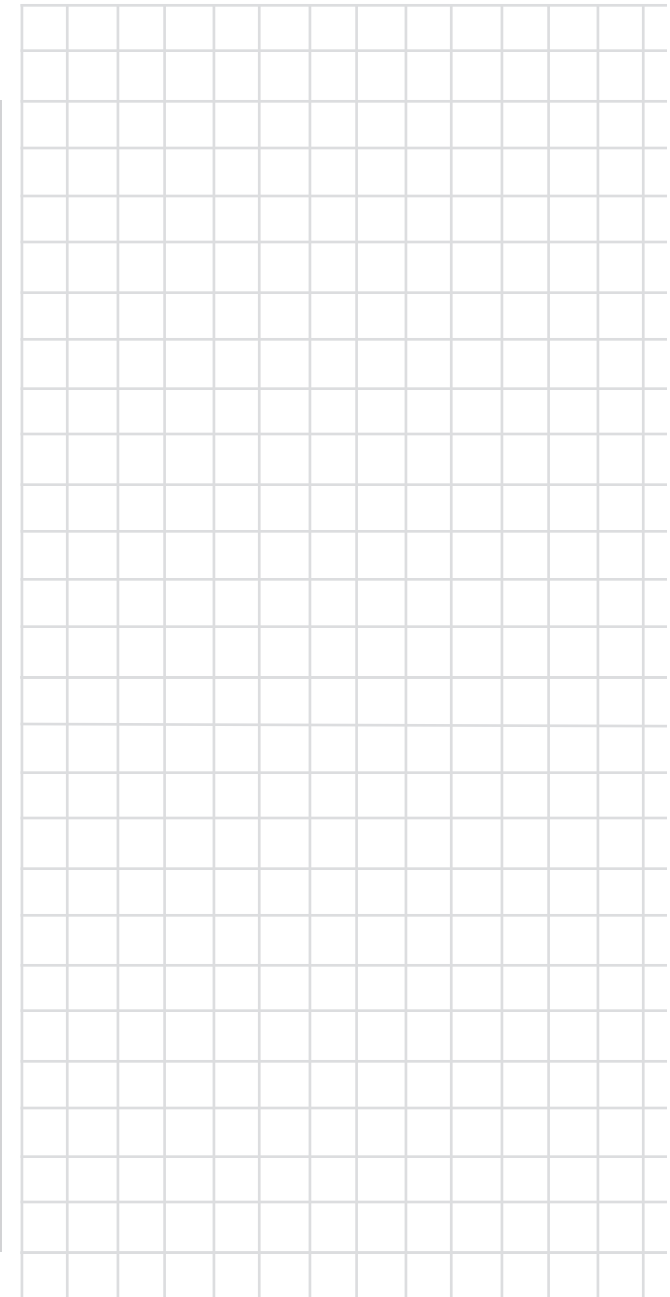

Figure 25





XM Radio Diagnostic Assistance

MR88 Information Display Indication	Possible Cause	Suggested Remedy	For Assistance Refer to
Check XM Tuner	The XM Mini-Tuner is not installed or not fully seated in the XM Mini-Tuner Dock or the XM Mini-Tuner dock is not connected to the MR88 Tuner.	Confirm the XM Mini-Tuner is fully seated in the dock and check the XM Mini-Tuner dock cable is connected to the MR88 Tuner.	MR88 Owner's Manual page 9 "How to Connect Optional XM Components".
Check Antenna	The XM antenna is not connected to the XM Mini-Tuner Dock or the XM antenna cable is damaged.	Check that the XM antenna is securely connected to the XM Mini-Tuner Dock and check the antenna cable for damage.	MR88 Owner's Manual page 9 "How to Connect Optional XM Components".
Loading	The XM Mini-Tuner is acquiring audio or program information from the XM satellite signal. This message can also occur in weak XM signal conditions. <i>Note: The MR88 Tuner may not respond to additional commands while this message is displayed.</i>	This message should disappear in a few seconds in good signal conditions. If you see this message often, reposition the XM antenna for better signal reception.	MR88 Owner's Manual page 18 Setup Mode "XM Radio Antenna Aim". See instructions supplied with the XM Mini-Tuner and Dock for antenna installation information.
No Signal	The XM Mini-Tuner is not receiving the XM satellite signal. Something may be blocking the XM antenna's view of the satellites or the antenna is not properly aimed.	Check for antenna obstructions and reposition the XM antenna to get better signal reception.	MR88 Owner's Manual page 18 Setup Mode "XM Radio Antenna Aim". See instructions supplied with the XM Mini-Tuner and Dock for antenna installation information.
Off Air	You selected a XM channel not currently broadcasting.	Check back later; in the mean time, select another channel.	MR88 Owner's Manual page 24 "XM Radio Channel Selection".
CH Unauthorized (Channel Unauthorized)	You selected a XM channel that is blocked or cannot be receive with your XM subscription package.	Consult the latest channel guide at www.xmradio.com for the current list of channels.	For information on receiving this channel, visit www.xmradio.com or contact XM Satellite Radio at 1-800-967-2346.
CH Unavailable (Channel Unavailable)	The selected channel is not available. The channel may have been reassigned to a different channel number. This message may occur initially with a new radio or a radio that has not received XM's signal for an extended period.	Consult the latest channel guide at www.xmradio.com for the current list of channels. For cases of a new radio or a radio that has not received XM's signal for an extended period, allow the radio to receive the XM satellite signal for at least 5 minutes and then try to select the channel again.	
-- --	No artist name or song title is available for this selection.	No action required.	

XM Radio Phone Assistance

In the unlikely event it becomes necessary to call XM Satellite Radio for Assistance to resolve a reception difficulty, the MR88 will need to be placed in the “:XM Radio Diagnostic” Mode to aid the technician in resolving the problem. Please perform the following steps:

1. Place the MR88 in the XM Receiving Mode by using the BAND Push-button.
2. Press the MONO/SETUP Push-button until the Front Panel Information Display indicates McIntosh MR88 V__._ firmware version, refer to figure 54.



Figure 54

3. Rotate the MENU (PRESET) Control clockwise until the informational display indicates “XM DIAGNOSTIC PRESS STORE”. Refer to figure 55.



Figure 55

4. Press the STORE/EXIT Push-button to enter the XM Diagnostic mode. At this time the Front Panel Information Display will indicate “DIAGNOSTIC MODE POWER OFF TO EXIT”. Refer to figure 56.



Figure 56

At this time follow the instruction given by the XM technician.



Figure 57

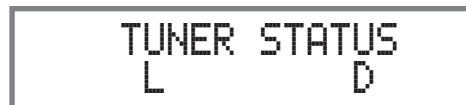

Figure 58

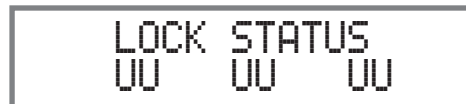

Figure 59



Figure 60



Figure 61



Figure 62



Figure 63



Figure 64



Figure 65



Figure 66



Figure 67

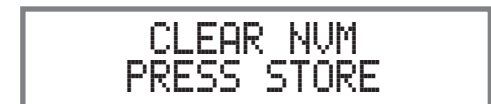

Figure 68



Figure 69



FM HD Radio Specifications

Sensitivity
-85dBm

Signal To Noise Ratio
85dB

Frequency Response
20 to 20,000Hz

Harmonic Distortion
0.1%

Stereo Separation
80dB

FM Analog Specifications

Useable Sensitivity
1.6uV (15.2dBf)

50dB Quieting Sensitivity
1.8uV (16.2dBf)

Signal To Noise Ratio
Mono: 75dB; Stereo: 72dB

Frequency Response
20 to 15,000Hz

Harmonic Distortion
Mono: 0.1%; Stereo: 0.4%

Channel Selectivity
65dB Adjacent Channel
74dB Alternate Channel

Stereo Separation
35dB

AM HD Radio Specifications

Signal To Noise Ratio
85dB

Frequency Response
20 to 15,000Hz

Harmonic Distortion
0.1%

Stereo Separation
75dB

AM Analog Specifications

Sensitivity
550uV/m

Signal To Noise Ratio
45dB

Frequency Response
100 to 3,500Hz

Harmonic Distortion
0.25%, 80% Modulation

Selectivity
50dB Adjacent Channel

General Specifications

FM Tuning Range and Channel Spacing
87.5MHz - 107.9MHz; 200kHz

FM Antenna Input
75 ohms, Type "F" Coax connector

AM Tuning Range and Channel Spacing
530kHz - 1710kHz; 10kHz

Rated Output
1Vms Unbalanced, 2Vms Balanced

Output Impedance
100 ohms Unbalanced or Balanced

Digital Output
Optical: - 15dbm to -21dbm (PCM)
Coaxial: 0.5V p-p/75 ohm (PCM)
Sampling Frequency: 48kHz (PCM)

AM Antenna Input
Balanced, RJ45 connector (for use only with supplied McIntosh RAA2 Remote AM Antenna)

RAA2 Remote AM Antenna Overall Dimensions
Width is 6 inches (15.24cm)
Height is 2-1/2 inches (6.35cm)
Depth is 1-1/2 inches (3.81cm)

Power Requirements
110V ~ 50/60Hz at 30 watts
120V ~ 50/60Hz at 30 watts
220V ~ 50/60Hz at 30 watts
Standby, less than 0.5 watt

Note: Refer to the rear panel of the MR88 for the correct voltage.

Overall Dimensions
Width is 17-1/2 inches (44.45cm)
Height is 6 inches (15.24cm) including feet
Depth is 18 inches (45.72cm) including the Front Panel, Knobs and Cables

Weight
25.5 pounds (11.6 kg) net, 40 pounds (18.1 kg) in shipping carton

Shipping Carton Dimensions
Width is 26-1/2 inches (67.3cm)
Depth is 24-1/4 inches (62.2cm)
Height is 11-3/4 inches (29.9cm)

Packing Instructions

In the event it is necessary to repack the equipment for shipment, the equipment must be packed exactly as shown below. It is very important that the four plastic feet are attached to the bottom of the equipment.

This will ensure the proper equipment location on the bottom pad. Failure to do this will result in shipping damage.

Use the original shipping carton and interior parts only if they are all in good serviceable condition. If a shipping carton or any of the interior part(s) are needed, please call or write Customer Service Department of McIntosh Laboratory. Refer to page 4. Please see the Part List for the correct part numbers.

Quantity	Part Number	Description
1	033838	Shipping carton only
4	033837	End cap
1	033836	Inside carton only
1	033725	Inner carton top pad
1	034301	Bottom pad
2	034446	Foam plug
4	017937	Plastic foot
4	400159	#10-32 x 3/4" screw
4	404080	#10 Flat washer

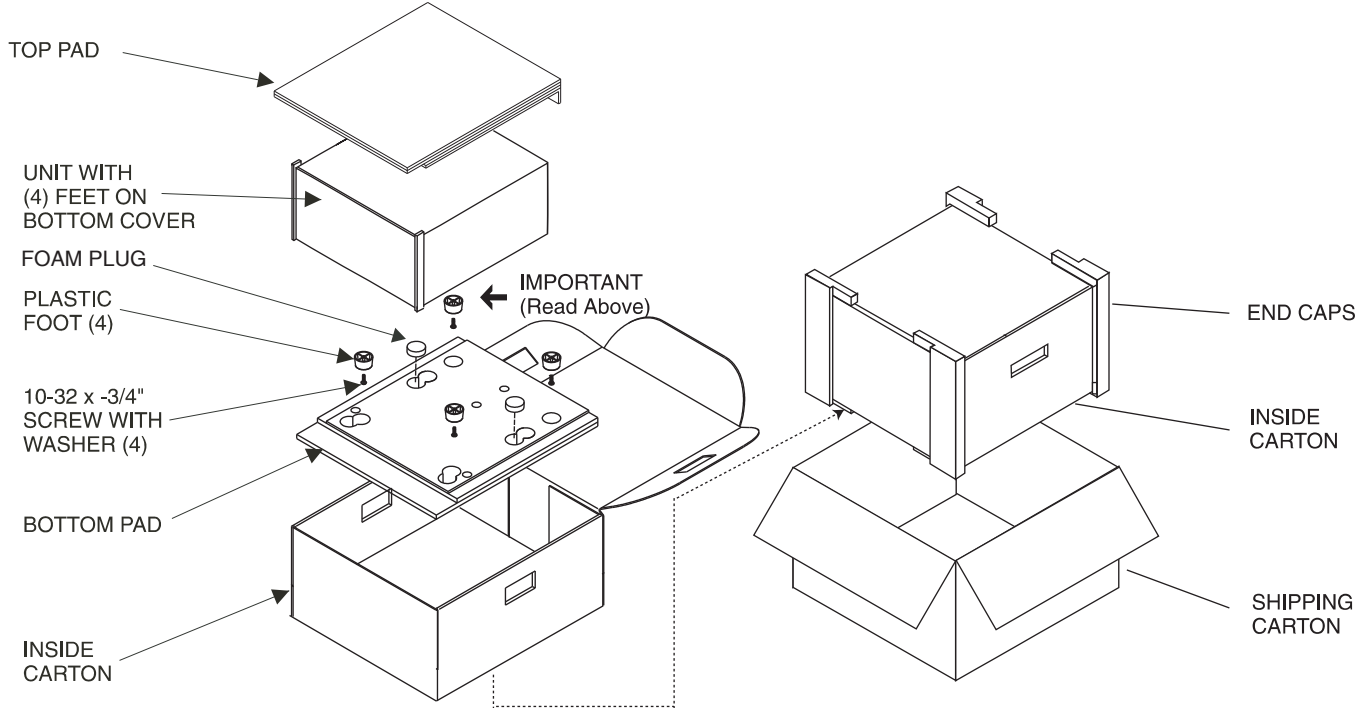



McIntosh Laboratory, Inc.
2 Chambers Street
Binghamton, NY 13903
www.mcintoshlabs.com

The continuous improvement of its products is the policy of McIntosh Laboratory Incorporated who reserve the right to improve design without notice.
Printed in the U.S.A.